



**Model**  
**M1PRO 40 M-Bus MID**

One phase energy meter, direct connection 40 A with MID declaration of conformity and M-Bus communication.

MID certification concerns active energy only.

User instructions.

**Safety instructions**

Read this manual carefully BEFORE installing the instrument.

This device must be installed indoor only by a professional electrician fitter according to local applicable installation standards.

Do not plug in or unplug this product when the power supplying is ON. Its use is only permitted within the limits shown and stated in the installation instructions. The device and the equipment connected can be destroyed by loads exceeding the values stated.

Any type of intervention on the products, including cases in which they cease to function or present defects, can be dangerous for the operator's safety and relieves the Manufacturer from all civil and criminal liability.

**Function**

This 4 quadrants meter measures the active energy used in an electrical installation. This device can manage 1 tariffs by 230 VAC digital input. Only the total active energy register can be used for billing purposes according to measuring instrument directive (MID).

- Active Energy Class B (according to EN 50470-3:2022)
- Active Power Class 1 (according to IEC 62053-21:2020 and IEC 61557-12:2018).

This device has a backlit LCD and 1 push-button keys to read Energies, V, I, PF and to configure some parameters. The design and manufacture of this meter comply with Standard EN 50470-3:2022 requirements.

**Power factor**  
Convention according to IEC 62053-23:2020

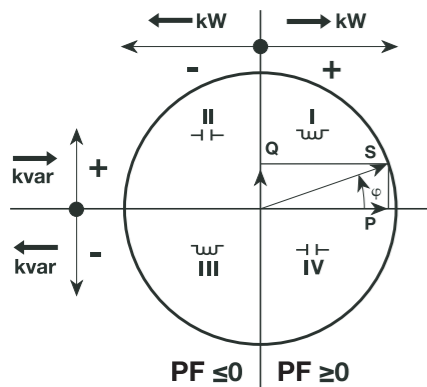

**Layout of device**

LCD display

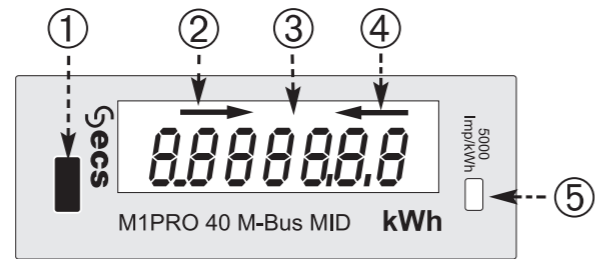

- 1) Command Button
- 2) (→) imported symbol (for Energy or Power)
- 3) 7 digit LCD, for Energy and instantaneous values visualization)
- 4) (←) exported symbol (for Energy or Power)
- 5) Metrological LED (5000 pulses per kWh)

**Displayed values**

Value	Unit	Symbol
Imported Active Energy	kWh	→
Exported Active Energy	kWh	←
Imported or Exported Active Power	W	W → / W ←
Voltage	V	V
Current	A	A
Frequency	Hz	Fr
Power Factor (4 quadrants)	-	PF

**Information on the side of the Meter**

CE M 24 0051  
343 / MD

CL B (Cl. 1)  
0.25-5(40)A  
230V ~ 50 Hz

- One measurement system, 1 Phase, 2 wires connection
- Protective class II equipment, Reinforced insulation
- Backstop (Energies cannot decrease)
- Obligation to read the manual before installation
- Bidirectional Communication  
In the models with M-Bus or Modbus on-board, the symbol is placed near the communication terminals.

**Dimensions**

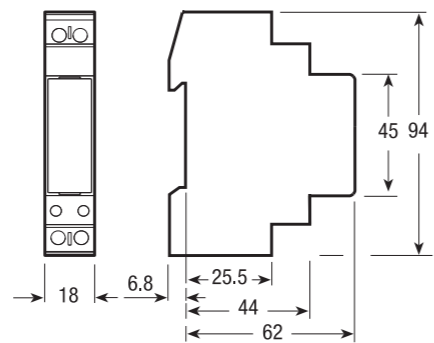

**Sealable terminal cover**

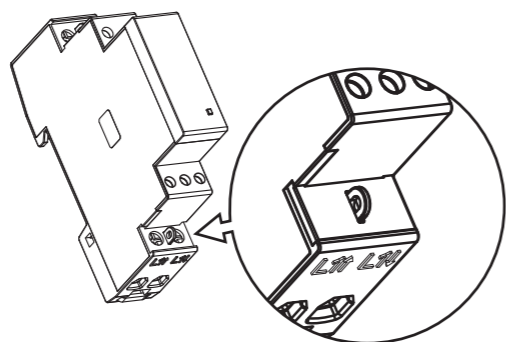

**Wiring**

**Intended use**  
The Energy Meter is suitable for use on both impedance grounded networks and not grounded networks.

**Electrical Safety (EN 62052-31)**

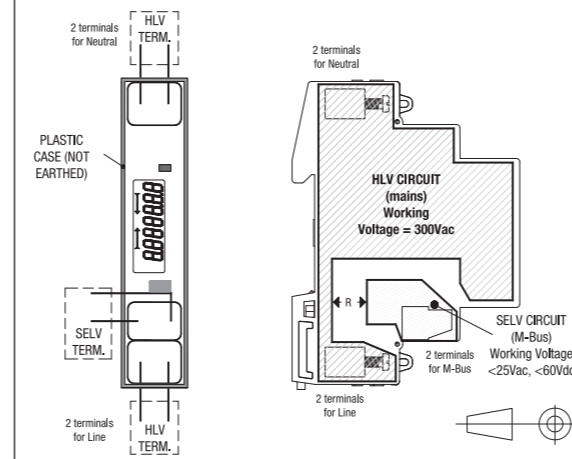

**There are no accessible parts**

- Legend:
- B = Basic insulation
  - D = Double insulation
  - R = Reinforced insulation
  - F = Functional insulation

Circuits definitions according to EN 62052-31 – Table 20  
Mains circuit "HLV Mains Circuit"  
Working Voltage 300 Vac  
Circuit for M-Bus: "SELV Circuit"  
Working Voltage <25Vac and <60Vdc

**Wiring diagram**

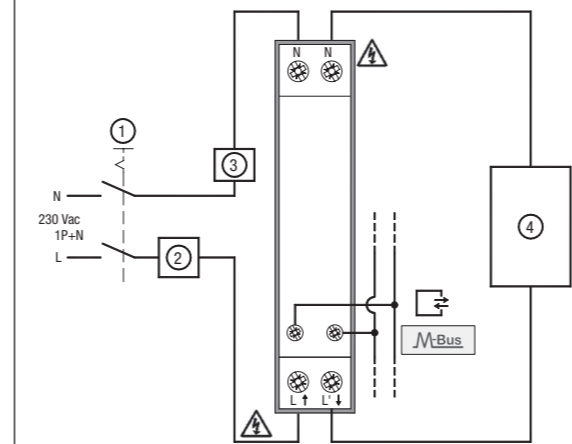

- 1) Bipolar disconnector 230Vac. The disconnector must be clearly labelled and must be easily accessible by the installer.
- 2) Fuse or circuit breaker.
- 3) Fuse or circuit breaker in series with the neutral conductor, to be adopted in case the source neutral is not earthed. The installer is responsible for coordinating the rating and the characteristics of the supply side overcurrent protection. The devices must be correctly sized with respect to the installation voltage, the maximum overcurrent applicable to the meter and the fault current available. The following parameters are to be taken into consideration:
  - Maximum current = 40A
  - Maximum Overload current = 48A
  - Maximum Voltage = 276 Vac
- 4) 2 wires load.

**Installation and uninstallation**

The disconnectors (reference 1 and 2 in the wiring diagram) must be easy to identify and to operate and must be close to the Meter. They both must be in "OFF" position (open circuits) from the beginning to the end of the installation or of the uninstallation. The Energy Meter, the disconnectors and the overload current protection devices must be easily identifiable, must be installed in an adequate cabinet (IP51 and V1) and it must be easy to intervene on them whenever appropriate. Inside the cabinet, do not install any other device with a flammability class worse than V1.

**Commissioning**

- Recommendations
- Check the following before putting it into service:
    - Make sure that no dangerous voltages are connected to the SELV terminals.
    - Make sure that a phase has not been connected to the Neutral terminal (this would cause the internal protections to intervene with permanent damage to the Meter).
    - Check that the main page appears on the display (see menu description) and not the Phase Sequence Error page.

**Maintenance**

- Make sure that no voltage is applied to the instrument.
- Only dry cleaning is allowed with a natural fiber cloth (for example cotton or linen) or synthetic fabric that does not leave residual fibers that can remain on the surface of the Energy Meter or that can penetrate into the Energy Meter.

For this Energy meter, no maintenance, repair or replacement of parts is foreseen. Such interventions are to be considered prohibited. In case of malfunction, it must be replaced.

**Help in case of problems**

Error condition  
When the display shows the message ERROR N02 or ERROR N03, the meter has got a malfunction and must be replaced.

**Cable section - Cable stripping length**

**Screwdriver type. Maximum terminal screw torque**  
Adopted cables shall retard flame propagation. Cables must therefore comply with IEC 60332-1-2:2004 or have a flammability rate UL 2556 VW-1. The conductive part of the cables must be copper.

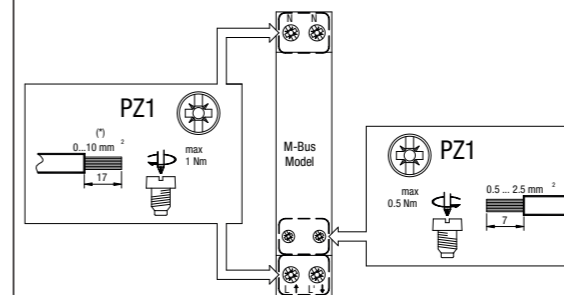

Note (\*): 0...10 mm<sup>2</sup> has the following meaning:  
- '0' means that the screw terminal closes completely even with no wire inserted.  
- If the maximum current that is expected to be applied permanently can reach 40 A (I<sub>max</sub>), it is mandatory to use a multi-wire cable with a 10 mm<sup>2</sup> section and to adopt a suitable fuse or disconnector (see Wiring Diagrams chapter). The use of cables with a smaller section falls under the responsibility of the installer, who must, in this case, ensure that the maximum permanent current (I<sub>max</sub>) and the overload current (I<sub>ov</sub>) remain proportionally lower for the entire duration of use.  
For example, with a cross section of 5 mm<sup>2</sup> the permanently applied current (I<sub>max</sub>) cannot exceed 20A and the overload current (I<sub>ov</sub>) 25A. The overcurrent protective device must therefore be sized accordingly.

**Notes**

## General Menu

▶ Active Exported Energy (→)	↓	8374506
▶ Active Imported Energy (←)	↓	6785678
▶ Active power (in this case Imported →)	↓	W 4971
▶ Voltage RMS	↓	V 2310
▶ Current RMS	↓	A 2834
▶ Frequency	↓	Fr 4998
▶ Power factor between -1.00 and +1.00	↓	Pfc-092
▶ M-Bus Primary Address	↓	Addr 49
▶ M-Bus Baudrate	↓	br 2400
▶ M-Bus Identifier number (also called Secondary Address)	↓	Id 0476
▶ Serial Number	↓	Sn 1625
▶ Year of Production	↓	Year 23
▶ Type of Instrument	↓	Energy
▶ Firmware checksum	↓	Ch 5C2A
▶ Firmware release	↓	rEL 106
▶ Display test Page		8.8.8.8.8.8

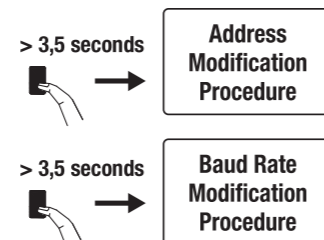

the value automatically rotates to show all 8 digits

## Technical data



Data in compliance with EN 62052-11:2021+A11:2022, EN 62052-31:2016-06, IEC 62052-31, EN 62059-32-1:2012

General characteristics			
Housing	DIN 43880	DIN	1
Mounting	EN 60715	DIN rail	35 mm
Depth		mm	62
Weight		g	60
Operating features			
Connection	to single-phase network - number of wires	-	2
Storage of energy values and configuration	Internal flash non volatile memory	-	☑
Approval (EN 62052-31:2016-06 EN 50470-3:2022)			
Reference Voltage (Un)		VAC	230
Reference Current (In)		A	5
Minimum Current (Imin)		A	0.25
Maximum Current (Imax)		A	40
Starting Current (Ist)		A	0.015
Transitional Current (Itr)		A	0.05
Reference Frequency (fn)		Hz	50
Number of phases / number of wires		-	1 / 2
Certified Measures		kWh	→ kWh ← kWh
Accuracy			
- Active Energies (accord. to EN 50470-3:2022)		classe	B
- Active Powers (accord. to IEC 62053-21:2020 and IEC 61557-12:2018)		classe	1
Supply Voltage and Power Consumption			
Operating Supply Voltage range		V	184 ... 276
Maximum Power Consumption (Voltage circuit)		VA	≤8
Maximum VA burden (Current circuit) @ Imax		VA	≤1.3
Voltage Input Waveform		-	AC
Voltage impedance		MΩ	1
Current impedance		mΩ	≤20
Overload capability			
Voltage	continuous	VAC	276
	temporary (1 s)	VAC	300
Current	continuous	A	40
	temporary (10 ms)	A	1200
Measuring Features			
Voltage range		VAC	184 ... 276
Current range		A	0.25 ... 40
Frequency range		Hz	45 ... 65
Measured Quantities		-	V, A, kWh, PF, Hz, kW
Display features			
Display type	LCD	-	7.0 / 5.2
Active Energy	5 digits + 2 decimal digits	kWh	0.01 ... 99999.99
Voltage	3 digits + 2 decimal digits	V	184 ... 276
Current	2 digits + 2 decimal digits	A	0.00 ... 40.00
Power factor	1 digit + 2 decimal digits with sign + capac./induc. indic.	-	-1.00 ... 1.00
Frequency	2 digits + 2 decimal digits	Hz	45.00 ... 65.00
Active Power	2 digits + 2 decimal digits with sign	kW	0.00 ... 11.04
Display refresh period		s	1
Optical metrological LED			
Front mounted red LED (meter constant)	proportional to active imp/exp Energy	imp/kWh	5000
Safety			
Utilization category		-	UC1
Overvoltage category		-	3
Protective class		classe	II
AC voltage test (EN 50470-3:2022)		kV	4
Degree of pollution		-	2
Operational voltage		V	300
Impulse voltage test (Uimp)		1.2/50 µs-kV	6.4
Housing material flame resistance		UL 94 classe	V0
Ultrasonic safety welding between upper and lower housing part		-	☑
Printed circuit board flammability class		-	V1
Material Group		-	IIIa
Embedded M-Bus communication			
Baud rate		bps	300 ... 9600
Unit load		-	1
Address adjustable		-	0 ... 250
Isolation class SELV		-	☑
Environmental conditions			
Storage temperature range		°C	-40 ... +85
Operating temperature range		°C	-25 ... +55
Mechanical environment		-	M1
Electromagnetic environment		-	E2
Installation	indoor only	-	☑
Altitude (max.)		m	≤2000
Humidity	yearly average, without condensation	-	≤75%
	on 30 days per year, without condensation	-	≤95%
IP rating	in built-in condition (front part)	-	IP51
	terminal block	-	IP20
Emission class compatibility CISPR 32		classe	B