



(GB)

<b>Code</b>	<b>Model</b>
ECSE509MID	M1PRO 80 M-Bus MID

One phase energy meter, direct connection 80 A with MID declaration of conformity and M-Bus communication.

MID certification concerns active energy only.

User instructions.

### Safety instructions

- Read this manual carefully BEFORE installing the instrument.
- This device must be installed indoor only by a professional electrician fitter according to local applicable installation standards.
- Do not plug in or unplug this product when the power supplying is ON. Its use is only permitted within the limits shown and stated in the installation instructions. The device and the equipment connected can be destroyed by loads exceeding the values stated.
- Any type of intervention on the products, including cases in which they cease to function or present defects, can be dangerous for the operator's safety and relieves the Manufacturer from all civil and criminal liability.

### Function

This 4 quadrants Modbus RTU meter measures the active and reactive energy used in an electrical installation. This device can manage 2 tariffs by 230 VAC digital input.

Only the total active energy register can be used for billing purposes according to measuring instrument directive (MID).

- Active Energy Class B (according to EN 50470-3:2022)
- Active Power Class 1 (according to IEC 62053-21:2020 and IEC 61557-12:2018)
- Reactive Energy Class 2 (according to IEC 62053-23:2020)
- Reactive Power Class 2 (according to IEC 62053-21:2020).

This device has a backlit LCD and 3 push-button keys to read Energies, V, I, PF, F, P, Q and to configure some parameters. The design and manufacture of this meter comply with Standard EN 50470-3:2022 requirements.

**Power factor**  
Convention according to IEC 62053-23:2020

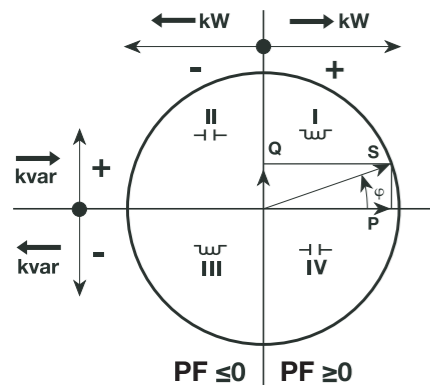

### Layout of device

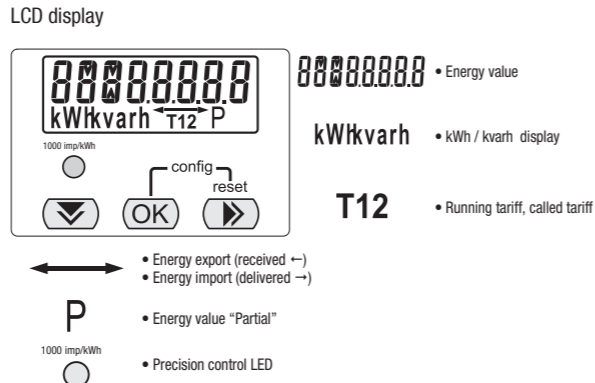

- Commands**
- Scroll Key:** This key is used to scroll pages and to modify parameters value. Its pushing is accepted only if it is shorter than 1.5 second.
  - OK key:** This key is used alone to enable a new menu function or to confirm a parameter value during its modification. Its pushing is accepted only if shorter than 1.5 seconds.
  - ESC key:** This key is used alone to exit from a sub-menu, to cancel a parameter modification or to go back to the main page. In these cases, its pushing is accepted only <1.5 seconds.
  - A long pushing (>1.5 seconds) of the "ESC key"** is used in the Partial Energy Registers Pages to reset their values.
  - Push these 2 keys together, for at least 1.5 seconds, to enter into the Configuration Menu.**

### MID certified

- A) Device code and certification data indications
- B) Safety-sealing between upper and lower housing part

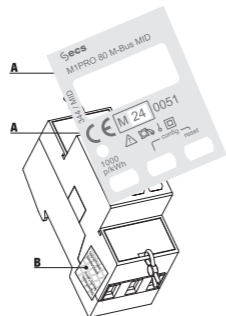

### Dimensions

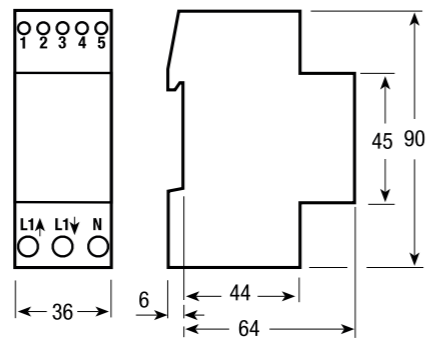

### Sealable terminal cover

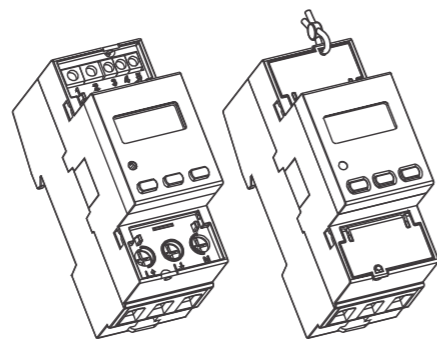

### Wiring

**Intended use**  
The Energy Meter is suitable for use on both impedance grounded networks and not grounded networks.

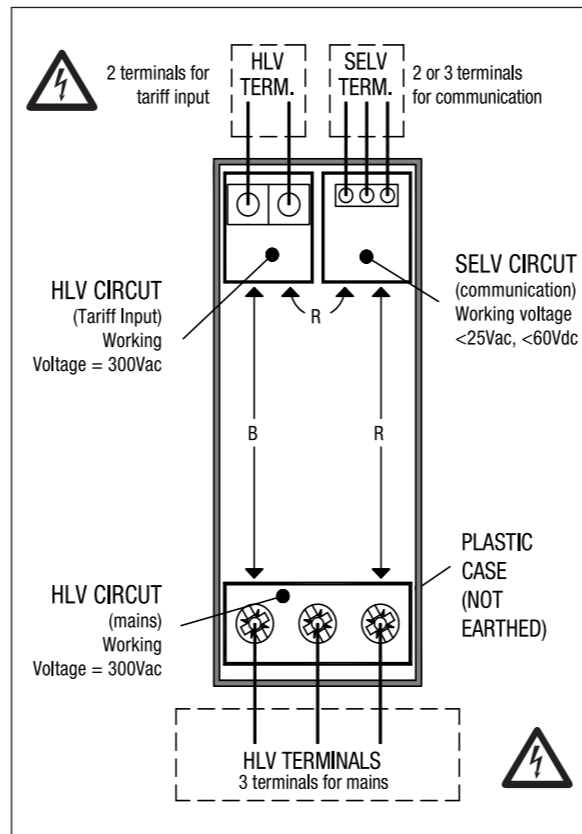

### Electrical Safety (IEC 62052-31:2015-09)

Insulation between parts (IEC 62052-31:2015-09 Annex B § B.5)  
The Energy Meter is suitable for use on both impedance grounded networks and not grounded network (EN IEC 62052-11:2021+A11:2022 § 6.5.1)

### There are no accessible parts

- Legend:
- B** = Basic Insulation
  - D** = Double Insulation
  - R** = Reinforced Insulation
  - F** = Functional Insulation
- Circuits definitions according to IEC 62052-31:2015-09 – Table 20  
Mains circuit "HLV Mains Circuit"  
Working Voltage 300 Vac  
Tariff Circuit: "Unearthed HLV non-mains circuit"  
Working Voltage 300 Vac  
Communication circuit: "SELV Circuit"

### Wiring diagram

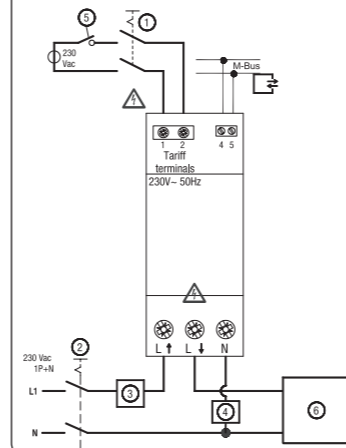

- ①② Bipolar disconnector 230Vac, 1P+N.  
The disconnectors must be clearly labelled and must be easily accessible by the installer.
- ③ Fuse or circuit breaker.
- ④ 3 fuses or 3 circuit breakers.  
Fuse or circuit breaker in series with the neutral conductor, to be adopted in case the source neutral is not earthed.  
The installer is responsible for coordinating the rating and the characteristics of the supply side overcurrent protection.  
The devices must be correctly sized with respect to the installation voltage, the maximum overcurrent applicable to the meter and the fault current available.  
The following parameters are to be taken into consideration:  
Maximum current = 80A  
Maximum Overload current = 100A  
Maximum Voltage <= 276 Vac
- ⑤ Control circuit for the tariff: Open contact: Tariff 1, Close contact: Tariff 2.
- ⑥ Two wires electrical load.

### Installation and uninstallation

The disconnectors (reference ① and ② in the wiring diagram) must be easy to identify and to operate and must be close to the Meter. They both must be in "OFF" position (open circuits) from the beginning to the end of the installation or of the uninstallation. The Energy Meter, the disconnectors and the overload current protection devices must be easily identifiable, must be installed in an adequate cabinet (IP51 and V1) and it must be easy to intervene on them whenever appropriate. Inside the cabinet, do not install any other device with a flammability class worse than V1.

### Commissioning

- Recommendations**  
Check the following before putting it into service:
- Make sure that no dangerous voltages are connected to the SELV terminals.
  - Make sure that a phase has not been connected to the Neutral terminal (this would cause the internal protections to intervene with permanent damage to the Meter).
  - Check that the main page appears on the display (see menu description) and not the Phase Sequence Error page.

### Maintenance

- Make sure that no voltage is applied to the instrument.
  - Only dry cleaning is allowed with a natural fiber cloth (for example cotton or linen) or synthetic fabric that does not leave residual fibers that can remain on the surface of the Energy Meter or that can penetrate into the Energy Meter.
- For this Energy meter, no maintenance, repair or replacement of parts is foreseen. Such interventions are to be considered prohibited. In case of malfunction, it must be replaced.

### Help in case of problems

**Error condition**  
If the display shows these messages, the meters has got a malfunction and must be replaced.

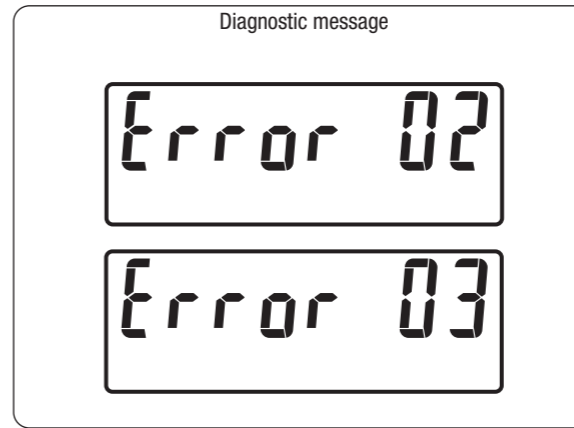

### Notes

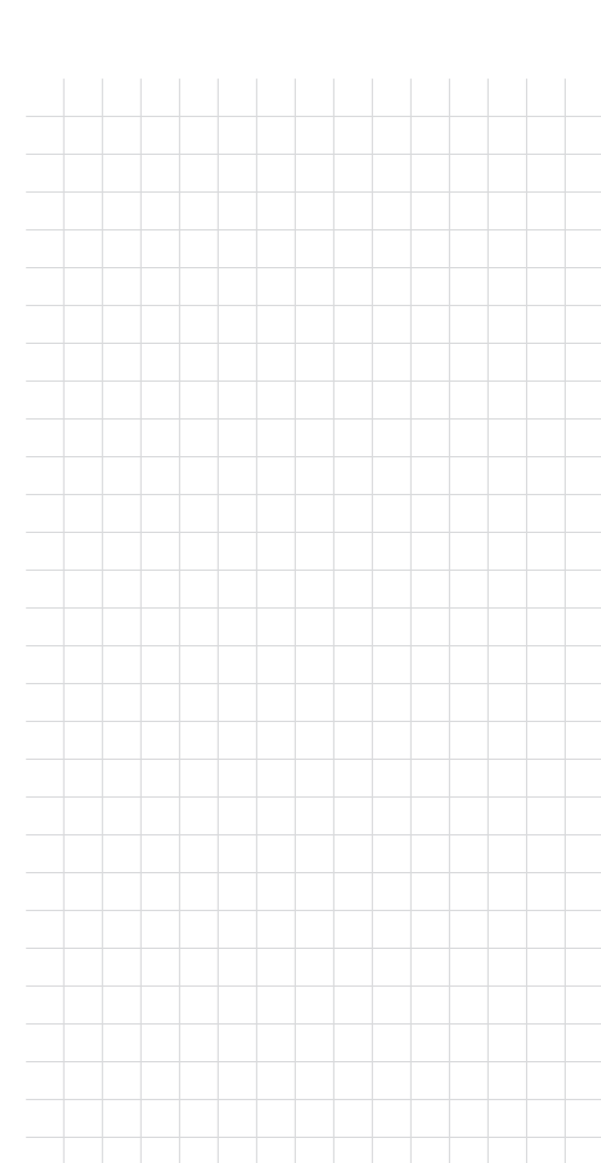

**Cable section - Cable stripping length**  
**Screwdriver type - Maximum terminal screw torque**  
Adopted cables shall retard flame propagation.  
Cables must therefore comply with IEC 60332-1-2:2004 or have a flammability rate UL 2556 VW-1.  
The conductive part of the cables must be copper.

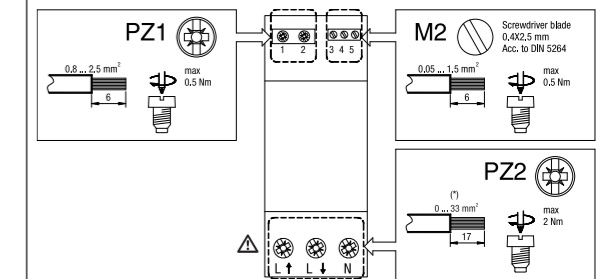

- '0' means that the screw terminal closes completely even with no wire inserted.
- If the maximum current that is expected to be applied permanently can reach 80 A (Imax), it is mandatory to use a multi-wire cable with a 33 mm² section and to adopt a suitable fuse or disconnector (see Wiring Diagrams chapter). The use of cables with a smaller section falls under the responsibility of the installer, who must, in this case, ensure that the maximum permanent current (Imax) and the overload current (Iovl) remain proportionally lower for the entire duration of use.  
For example, with a cross section of 10 mm² the permanently applied current (Imax) cannot exceed 40A and the overload current (Iovl) 50A. The overcurrent protective device must therefore be sized accordingly.

# General Menu

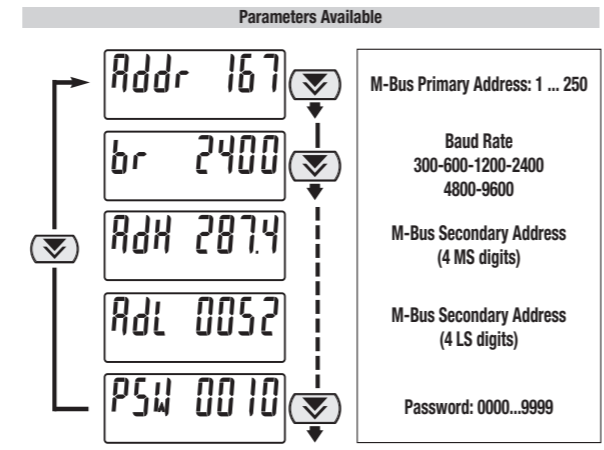
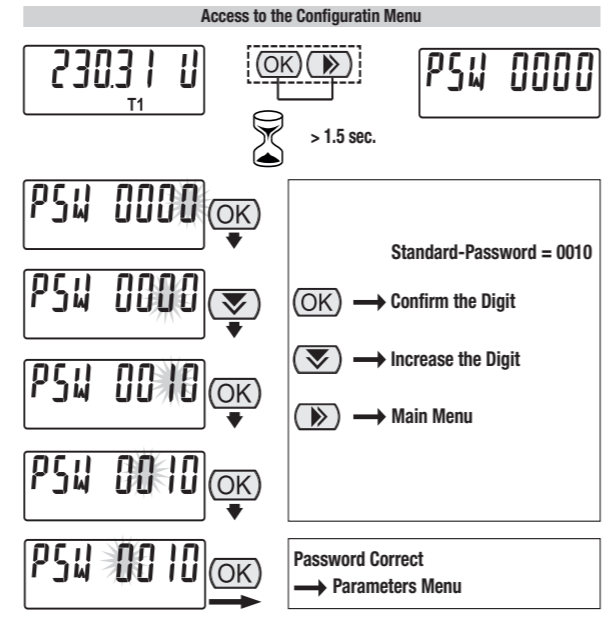
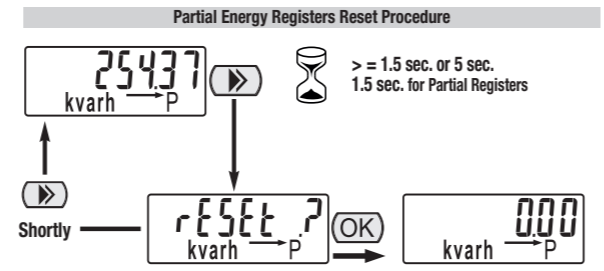
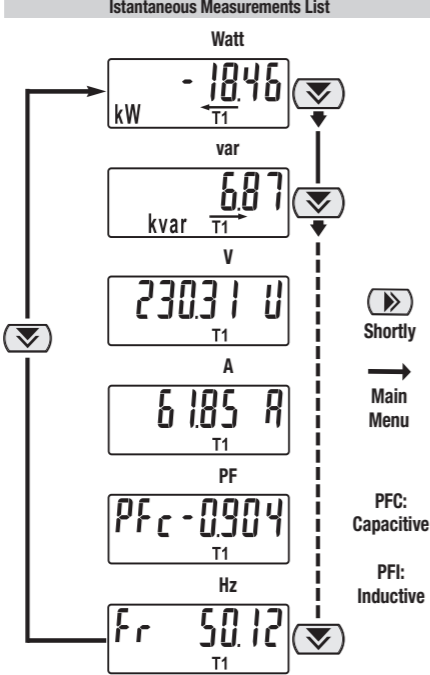
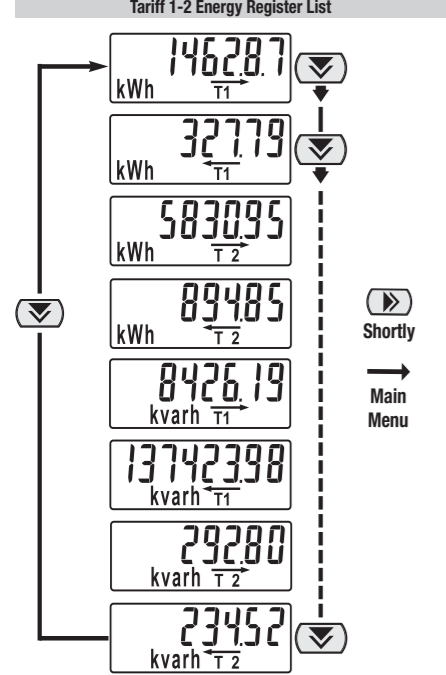
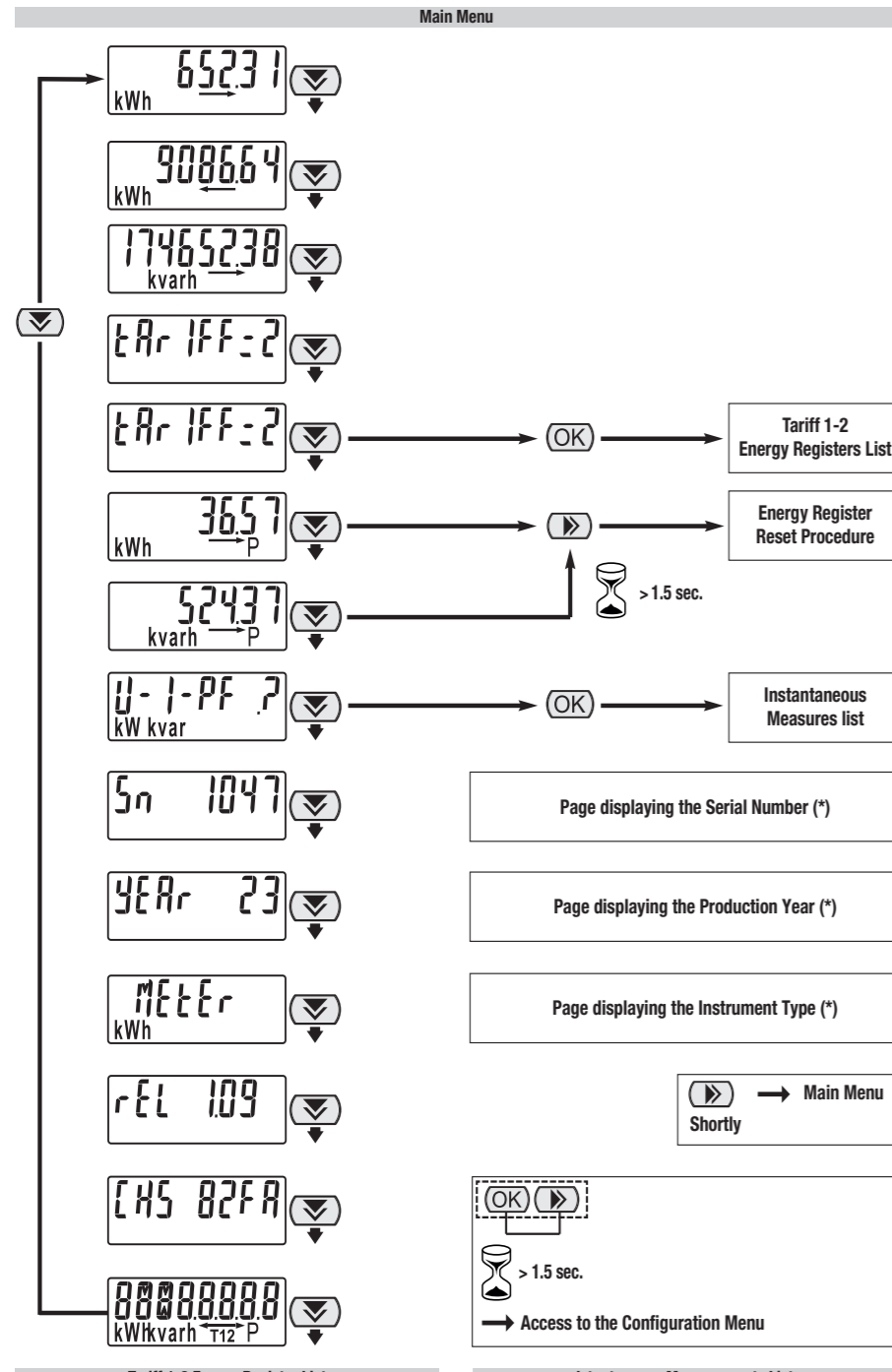

# Technical data

Data in compliance with EN 62052-11:2021+A11:2022, EN 62052-31:2016-06, IEC 62052-31, EN 62059-32-1:2012

General characteristics			
Housing	DIN 43880	DIN	2
Mounting	EN 60715	DIN rail	35 mm
Depth		mm	64
Weight		g	175
Operating features			
Connection	to single-phase network - number of wires	-	2
Storage of energy values and configuration	Internal flash non volatile memory	-	✓
Tariff	for active and reactive energy	-	T1 ... T2 230V
Approval (EN 62052-31:2016-06 EN 50470-3:2022)			
Reference Voltage (Un)	phase / neutral	VAC	230
Reference Current (In)		A	5
Minimum Current (Imin)		A	0.25
Maximum Current (Imax)		A	80
Transitional Current (Itr)		A	0.05
Starting Current (Ist)		A	0.015
Reference Frequency (fn)		Hz	50
Number of phases / number of wires		-	1 / 2
Certified Measures		kWh kWh	kWh
Accuracy		classe	B / 1
- Active Energies (accord. to EN 50470-3:2022)		classe	B / 1
- Active Powers (accord. to IEC 62053-21:2020 and IEC 61557-12:2018)		classe	2
- Reactive Energies (accord. to IEC 62053-23:2020)			
- Reactive Power (accord. to IEC 62053-21:2020)			
Supply Voltage and Power Consumption			
Operating Supply Voltage range		V	92 ... 276
Maximum Power Consumption (Voltage circuit)		VA / W	≤2 / ≤0.6
Maximum VA burden (Current circuit) @ Imax		VA	≤2
Voltage Input Waveform		-	AC
Voltage impedance		MΩ	1
Current impedance		mΩ	≤20
Overload capability			
Voltage	continuous phase / neutral	VAC	276
	temporary (1 s) phase / neutral	VAC	300
Current	Maximum	A	96
	temporary (10 ms)	A	2400
Measuring Features			
Voltage range	phase / neutral	VAC	184 ... 276
Current range		A	0.25 ... 80
Frequency range		Hz	45 ... 65
Measured Quantities		-	V, A, kWh, kvarh, PF, Hz, kW, kvar
Display features			
Display type	LCD with backlight	-	7.2 +3.2
Active Energy	7 digits + 2 decimal digits	kWh	0.01 ... 999999.99
Voltage	3 digits + 1 decimal digit	V	92.0 ... 276.0
Current	2 digits + 2 decimal digits / 3+1 / 4+0	A	0.00 ... 80.00
Power factor	1 digit + 3 decimal digits with sign + capac./induc. indic.	-	-1.000 ... 1.000
Frequency	2 digits + 2 decimal digits	Hz	45.00 ... 65.00
Active Power	2 digits + 2 decimal digits	kW	0.00 ... 22.08
Reactive Power	2 digits + 2 decimal digits	kvar	0.00 ... 22.08
Apparent Power	2 digits + 2 decimal digits	kVA	0.00 ... 22.08
Running Tariff	1 digit	-	T1 ... T2 230V
Display refresh period		s	1
Optical metrological LED			
Front mounted red LED (meter constant)	proportional to active imp/exp Energy	imp/kWh	1000
Safety			
Utilization category		-	UC2
Overvoltage category		-	3
Protective class		classe	II
AC voltage test (EN 50470-3:2022)		kV	4
Degree of pollution		-	2
Operational voltage		V	300
Impulse voltage test (Uimp)		1.2/50 μs-kV	6.4
Housing material flame resistance	UL 94	classe	V0
Safety-sealing between upper and lower housing part		-	✓
Printed circuit board flammability class		-	V1
Material Group		-	IIIa
IR Connectable Communication Modules			
For communication modules		-	✓
Embedded M-Bus communication			
Baud rate		bps	300 ... 9600
Unit load		-	1
Address adjustable		-	0 ... 250
Isolation class SELV		-	✓
Tariff			
Tariff 1		-	✓
Tariff 2		VAC	230 ±20%
Input impedance		kΩ	224
Environmental conditions			
Storage temperature range		°C	-40 ... +85
Operating temperature range		°C	-25 ... +55
Mechanical environment		-	M1
Electromagnetic environment		-	E2
Installation	indoor only	-	✓
Altitude (max.)		m	≤2000
Humidity	yearly average, without condensation	-	≤75%
	on 30 days per year, without condensation	-	≤95%
	in built-in condition (front part)	-	IP51(*)
	terminal block	-	IP20
IP rating		-	IP20
Emission class compatibility CISPR 32		classe	B
Durability Certification			according to EN 62059-32-1